

6"x 4" Model K Hinges

Model Number: 2100-K-RH-316

Price: £ 805

- Material Type: 316L Stainless Steel
- Maximum Vertical Load: 4,000 LBS
- Maximum Radial Load: 1,630 LBS
- Approx. Width: 4"
- Height: 6"
- Leaf Thickness: 1/2"
- Weight: 12 LBS

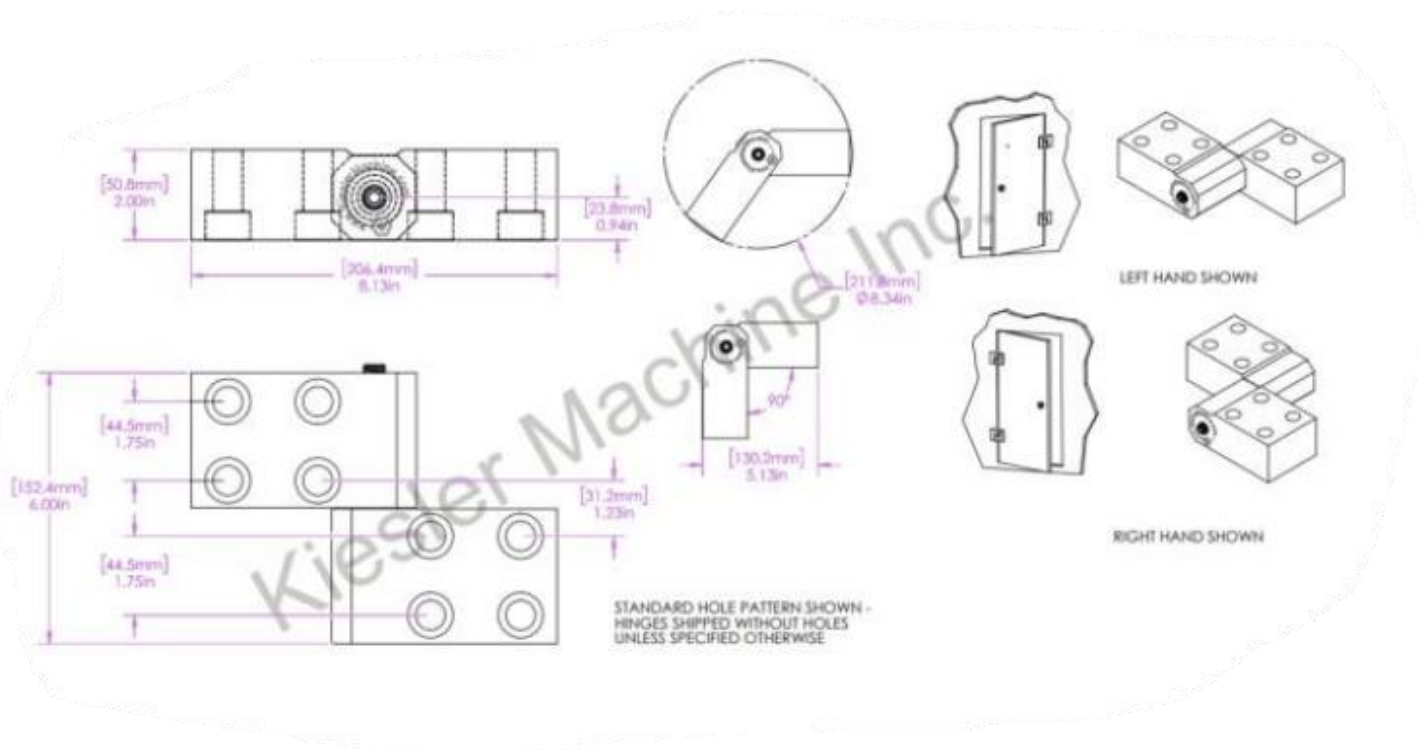

Kiesler Machine Inc

Contact Info :
info@kieslermachine.uk

Smoother Than The Rest
Guaranteed!

Data Provided For Reference Only.

Disclaimer: This drawing is property of Kiesler Machine Inc, Kieslermachine.com. It is owned with the understanding that it will in no way be used in a manner which is harmful to Kiesler Machine Inc.