

9"x 8"x 75" Model K Hinge

Model Number: 2150-K-RH-304

Price: £ 1990

- Material Type: 304L Stainless steel
- Maximum Vertical Load: 13,000 LBS
- Maximum Radial Load: 6,820 LBS
- Approx. Width: 8.75"
- Height: 9"
- Leaf Thickness: 1"
- Weight: 61 LBS

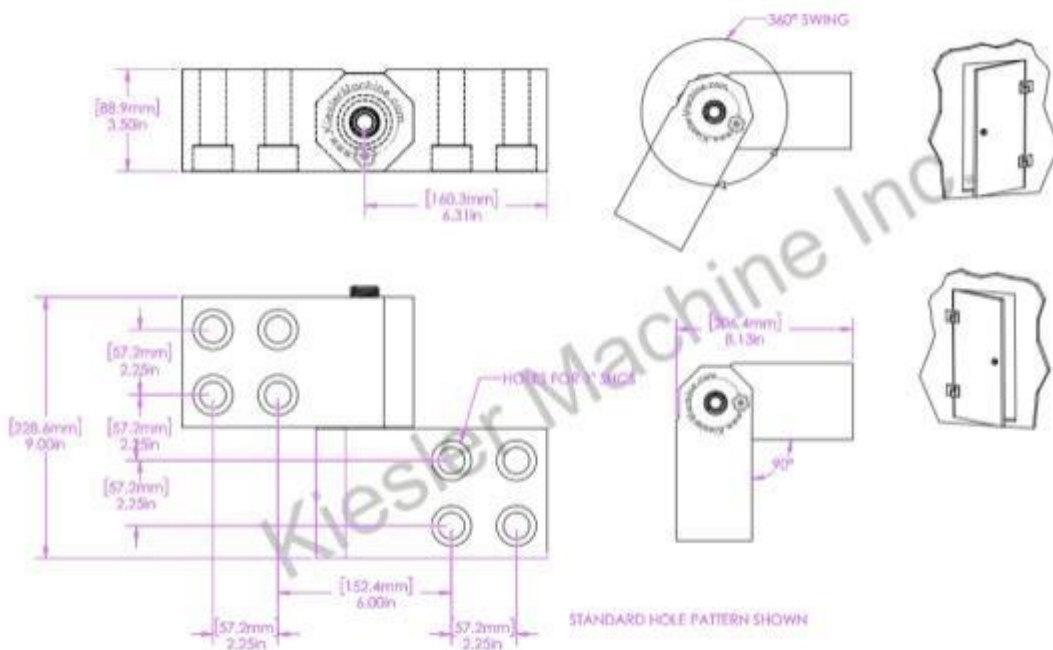

Kiesler Machine Inc



Contact Info :
info@kieslermachine.uk

Smoother Than The Rest
Guaranteed!

Data Provided For Reference Only.

Disclaimer: This drawing is property of Kiesler Machine Inc, Kieslermachine.com. It is owned with the understanding that it will in no way be used in a manner which is harmful to Kiesler Machine Inc.