

14" x 12 5/16" Carbon Steel Heavy Duty Hinges

Model Number: 2250 LH

Price: £ 2510

- Maximum Door Weight: 25,000 LBS
- Maximum Radial Load: 14,000 LBS
- Approx Width: 12 5/16"
- Height: 14"
- Leaf Thickness: 1 1/4"
- Weight: 105 LBS
- Mount: Weld On
- Material Type: Carbon Steel
- Finish: Primer

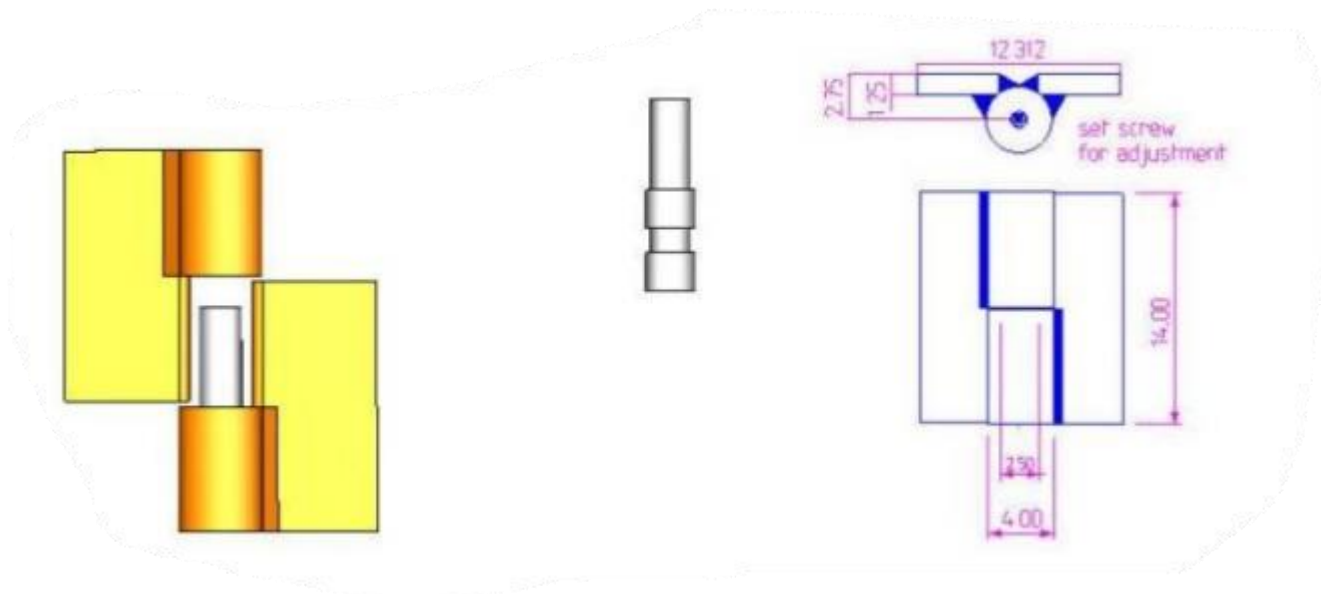
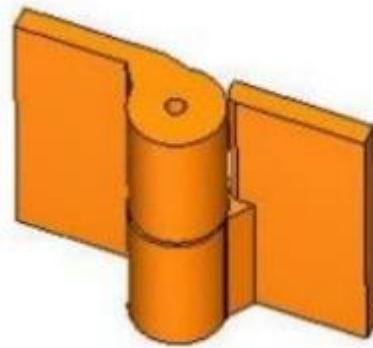

Kiesler Machine Inc

Contact Info :
info@kieslermachine.uk

Smoother Than The Rest
Guaranteed!

Data Provided For Reference Only.

Disclaimer: This drawing is property of Kiesler Machine Inc, Kieslermachine.com. It is owned with the understanding that it will in no way be used in a manner which is harmful to Kiesler Machine Inc.